

## The Electrical Voltage Setting 0-220 Volts by Software

Supawud Nedphograw, Somkeait Thongkeaw, Srisak Noiraiphom,  
Poonsri Wannakarn and Nitipan Khunprasert

*Department of Electrical Engineering, Faculty of Engineering,  
Rajamangala University of Technology Phra Nakhon (RMUTP)  
1381 Piboonsongkrum.RD Bangsei North Bangkok 10800. Thailand.  
:Supawudn\_p\_g@hotmail.com*

### Abstract

This project is the study about making the electrical voltage setting 0 – 220 Volts by software system with electrical voltage control of the auto transformer while it has 100 kv 10 kVA Especially the electrical voltage control has 65 ampares ,0-220 volt ,1 phase 50 Hz By the application of Visual Basic version 6 to the software and then use the micro controller in the board to control the stepper motor by setting the core of the auto transformer in the set of pattern while a computer is setting far away from the electrical High Voltage control and then it will apply the measurement system to the monitor display of software process system for development of software to the electrical Voltage section in the Electrical High voltage Lab to safety the danger of the test.

**Key words:** Electrical High voltage Laboratory

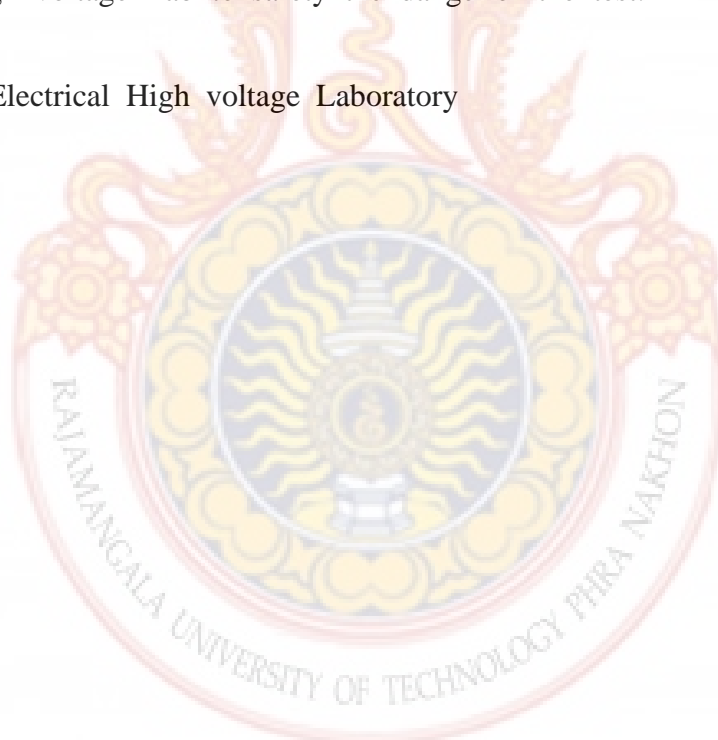

## 1. Introduction

### 1.1 Source of Problem and Idea

According to the Electrical High voltage lab which has testing the high electrical voltage by using Auto Transformer. The Electrical voltage controlling is using manual system which might danger from the high voltage testing. Therefore it should have the idea for controlling the low voltage a part from high voltage system and willing to develop electromotive force and measurement system in lab through software system.

## 2 Theory Concern

### Visual Basic Program

Visual Basic is a Programming Language which has develops by Microsoft Company. The company that created Window 95/98 Operating System and Window NT which is using in present day. The Programming Language is base from the Basic Language (Basic abbreviation from Beginner's All-Purpose Symbolic Instruction). Or it can interpret to be the "Program Language or Basic Language for beginner". Basic Language has the strength point is the person who do not have knowledge in writing program; they could learn and use the program easily and faster than learning other computer languages.

### Visual Basic Edition and Differences

Microsoft has divided the visual basic program in various groups which is according to the usage and prices as following.

- Learning Edition is suitable for study about the visual basic language. It would not much components but there are still the basic components that enough for programmer to created many programs

on the Window 95/98 or Window NT Operating System

- Professional Edition, this version including various components which is suitable for professional programmer who would like to create program or develop system for customer that using Window Operating System. . There are additional components from learning Edition such as ActiveX control, added Internet Information Server Application Designer, Visual Database Tools and Data Environment, Active Data Object and HTML (Hypertext Markup Language)

- Enterprise Edition is the version that has components and complete equipment. There would have everything that Professional Edition has. Together with tools concerning about program development for Network Development Management in team. Include tools that connect to others device of Microsoft.

### 2.1.1 Object, Property and Visual Basic

- Object in Visual Basic means to small

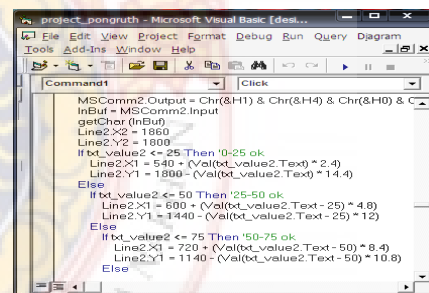

components of Window Program such as

Form, Command Button, Option Button, Test Box and Control Buttons. Property means qualification or characteristic of that object.

- IDE and other components of IDE. IDE or Integrated Development Environment means the atmosphere in the working place in program development by

using visual basic or other devices which has prepared by Microsoft that is ready for using in program development too. Visual Basic, when open the visual basic program, program would appear on IDE which would consist main components as the figure 2.1

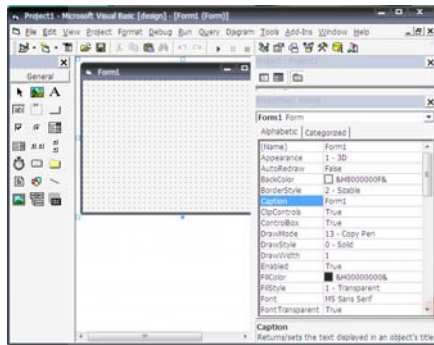

Figure 2.1 IDE Screen

2.1.2 Window Form is a blank window or blank form for create components of application by bring various object put into form. In other words is a program screen that user will see during using the program. When begin to use visual basic, it would usually appear blank form. Recall a form by pressing Shift +F7 key or call from Menu View > Object. See figure 2.2

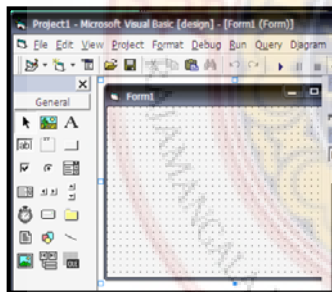

Figure 2.2 Window Form

2.1.3 Window Code Editor is a space for writing a program. Call program by using Menu View > Code or double click at object in form that window code editor will show together with entering the program for the main object. Figure 2.3 Window Code Editor Microsoft

Comm Control is a Control which is using in writing program through serial port (RS-232) by specifies custom control. Enter into Menu Project ---> Components and then select MSComm. It would appear the yellow telephone icon. Then click at the icon and drag to put into Form in Project of our program by follow the method on Figure 2.3

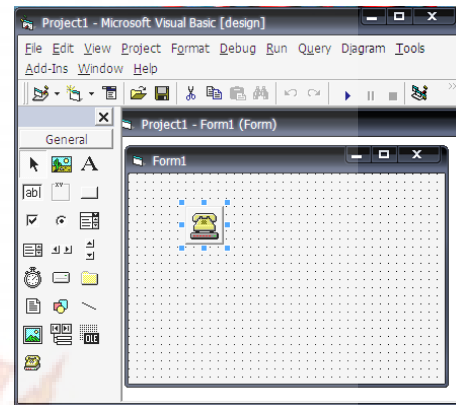

Figure 2.3 Choosing Component MsComm

#### 2.1.4 Procedure of Create Application Program

To create Visual Basic Application Program consist of 3 main steps as follow

- To create Interface by using Form to be Basic Object and to be a place for putting control for connects to user.
- Set up qualification to determine behavior and working for several objects.
- Command Writing is to control processing via Procedure which has determined. Command in connecting to serial port Knowing serial port, to move the information from computer to others device or sequence computer to receive the information once a bit but it could receive many bits in one time. If there are agree between sender and receiver that how many bits would be received in one time. Receiver has to wait for all bits have been sending before doing the processing result which would effect to communication of sequence information have slow speed than parallel. The amount of cable in sending and

receiving sequence information will use less cable which is at least 2-3 cable only. The speed rate in sending and receiving information may be slower than parallel which make the distance in communication of sequence would be more usable. Sequence Communication, it can divided into 2 types. There are Synchronous Sequence and Asynchronous Sequence. Synchronous will have clock signal in receiving and sending signal too. Example of sending information of synchronous is keyboard of computer. There would one line that connected at least 3 lines. There are clock signal, information and ground. Figure 2.5 showing about timing diagram of sending information in synchronous types.

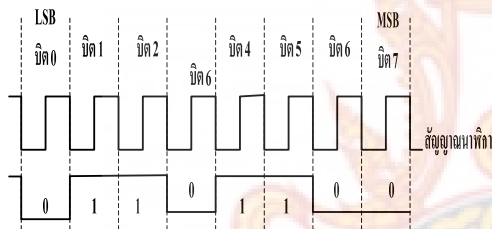

Figure 2.4 The most easier of sequence information

### 2.1.5 Serial Port RS-232 Standard

Standard for connecting serial port RS 232 to be the industrial standard which has design for sending sequence information of Asynchronous in 2 ways. The RS-232 Standard, in the pass there are design for sending information from computer to modem only. To send information from modem, it would send through telephone line to another computer that far away. Electronic Industries Association: EIA has set standard which is called EIA RS-232. This standard in the beginning will using connector DB-25 by specify the maximum signal at 50 foot. There

having signal level from -3 to -12 V which is showing that Mark and +3 to +12V which is show the Space.

### 2.1.6 UART

UART came from the word “Universal Asynchronous Receiver Transmitter” which is means of device that function in receiving and sending asynchronous information. For sequence communication on computer, UART is the heart of sequence communication. The main duty of UART is to transform information which is in parallel form in computer into asynchronous sequence form. Then sending out and transform asynchronous sequence signal transfer into UART to be parallel form before sending to computer. And inform other information for computer to acknowledgement such as information sending and receiving rate, Sending information form, mistake that occur during transform information (mistake from parity, information frame, over run).

2.1.7 Writing program for using in serial port Before using serial port, there should specify the beginning configuration. It has to specify the amount of bit information that has to be send, the ending bit, type of parity, and Bot rate. For specify, it can be used in many ways. First method is to specify from dos prompt by using Mode which is the following method but when using this command during program working in window processor, it would not be able to use because window process has settle a part into serial port of the operating system. Therefore, to recall in using, it’s necessary to call through tools via operating system such as using control MSCOMM32 OCX of Visual Basic Program.

### 2.1.8 MSComm Control

For using Visual BASIC from 2 version, in Visual BASIC, it would have custom control for sequence communication through serial port of computer. Visual BASIC version 2 and version 3 would be in

the name MSCOMM. VBX for working with operating system 32 bit for Visual BASIC version 5, there would be only MSCOMM32. There are only OCX because it is design for using with operating system 32 bit. MSCOMM has provided 2 ways for convenient information communication. First way is to communicate information that event-driven communications. This is the pattern usage that has more efficient for response immediately such as when text is send to serial port or having change at Data Carrier Detect (DCD) or Request To Send (RTS). MSCOMM of Oncomm event will detect the signal immediately. Detail in qualification topic of CommEvent is the option two that detecting for the event and mistake which has occur by seeing the change within qualification CommEvent after program has been working in each function. This method is doing well in case of small program. Control MSCOMM 1 can control serial port work for 1 port. If these program that using need to connect to serial port which has more than 1 port. It has to use control MSCOMM for control serial port in each port. Address of serial port and address that has interrupted changing from correcting at Control Panel. Micro Controller MCS-51 Micro Controller in MCS-51 is Micro Controller size 8 bit that has support devices combine inside such as RAM, Program Memory, Time set up/counting device for sending and receiving information serial. According to the structure of Micro Controller has support device which is help easily using and more efficiency. There is no need to use other additional devices like Micro Professor. Micro Controller MCS-51 Number P89C51 of Philips Company. Structure inside of Micro Controller MCS-51 P89C51

Infrastructure inside Micro Controller P89V51 that shows in figure 2.5, there are consists with devices as following: RAM inside for keep the program size 64 Kbyte. RAM inside for keep the program size 1 Kbyte. Time Set up and Counting Device size 16 bit for 3 sets. Controlling Port for serial communication UART In put – Out put Port

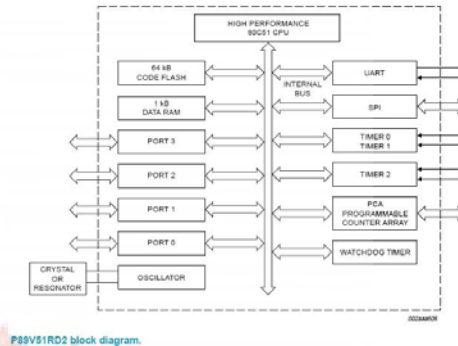

Figure 2.5 Infrastructure of Micro Controller C Writing Command will use C Language.

## 2.2 Stepper Motor

### 2.2.1 Stepper Motor Definition

Stepper Motor is device for electrical engine that transform signal from digital pulse to be rotation. The character of rotation or moving step by step but pulse will come in one by one that can be known the correct position. At present, stepper motor often applies to using with computer device such as printer.

### 2.2.2. The working of Stepper Motor

Stepper Motor has different from others motor. When entering electricity, it would a bit rotation at periphery and stop. That is the differences from normal motors that would more detail by using computer to define and collection those numbers. Stepper Motor could be used in Open Loop System. It can work without Feedback but every method has to define the position correctly. It is necessary to feedback to system and would point out the correct position or any Error. Another way that has been using with

Stepper Motor is to use Limit Switch setting at the position which needs to be detected. When Stepper Motor start to rotation and will rotate until the position of Limit Switch. It will feed back to the system and it would know the working of Stepper Motor at all time. Normally Controller cycle would define Reference Point for start working and Reference position correctly. If starting to pay the electricity power to floppy disk drive. It would be heard it moving for finding reference point which has define. After that drive controller cycle will start working. It will know every step that moving in reading or writing in each track on disk. General motors, it will start Rotor rolling when there is action of magnetic field that occurs between rotor and stator. It is up to setting of the pole. The rotation is made both continuous and twists back and forth. The power switch or carbon brush setting and set up commutator and switching electricity power to magnetic attraction at the pole and switching to stop. The result would be magnetic field rolling up to stator by paying electric power to the different direction of pole all the time. If there are wanted to stop rolling by stop at the pole and stop switching at the next sequence. To twist direction, it can be done as same as what had mention before, just switching electric power to create magnetic field in opposite direction. Structure of Pole on stator is consisting from plate ring which has cog project out. Each cog, it would coil so that when enter electric power through coil, it would has electromagnetic. On the opposite side in each pole, it would receive the electricity at the same time. As show in Figure 2.7. So that if there are increasing of pole, it will increasing amount of step in each ring too. However, user can increasing the

amount of step in another way without changing the inside structure. By paying electric power to 2 poles that is near in the same time. It would make rotor to stop rolling between those 2 poles or moving to half step only. This method is also help to have more torque too. As showing in Figure 2.8.

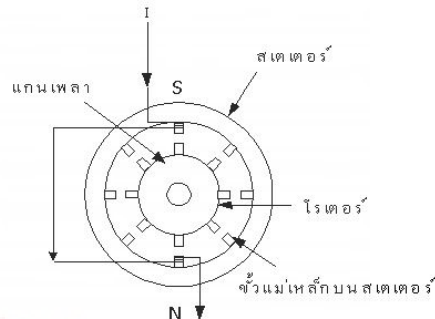

Figure 2.6 Showing the step motor that effect to the inside circuit coil that will stimulate to 1 pole. In opposite direction, other coils are not any stimulate.

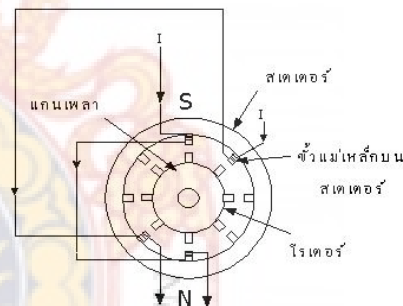

Figure 2.7 Showing stimulate circuit coil that make 2 poles which is close to one another happen at the same time. This makes rotor to moving between those 2 poles.

## 2.3. AUTO TRANSFORMER

### 2.3.1. Introduction

Automatic Voltage Regulator has design for paying electricity power which is convenient to use. For the parts that drive Variac to roll, it would use D.C. motor to control the suitable speed. This chapter will talk about the theory of working in each part.

### 2.3.2. AUTO TRANSFORMER

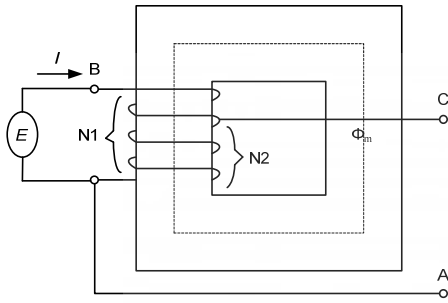

Figure 2.8 AUTO TRANSFORMER

AUTO TRANSFORMER is the transformer with coil. It is only one set of coil on the top of core and this coil will receive and turn on the power which would save coil and more cheaply than normal transformer. While comparing transformer size, this transformer would be used to transform voltage that has Transformation Ratio which is slightly different from others. According to Figure N1 it is the amount of coil in Primary (A–B Terminal) side and N2 coil in Secondary (A–C Terminal) side. Primary coil is connecting to supply E1. When there are induce current  $I_0$  flow into coil, it would have magnetic filed  $\Phi_m$  at core. For C point at Tab, it would be between A-B for using coil in Secondary which has the same amount with N2. It will have force induction between these 2 points. This Force Induction will occur more or least, it is up to the amount of coil.

Principle Design and Set up Voltage Adjustment 3.1 Introduction

Set up Voltage Adjustment 0-220 volt through software, it will use Visual Basic V.6 program to connect with sending and receiving signal control by Microcontroller via port RS 232 of computer. Working to control of Motor Stepper Unipolar 4 phase. Drive the core of Auto Transformer for adjusting force

0-220 volt and setting up meter to collect parameter at the secondary side of Auto transformer. Sending and receiving parameter information through electric for program to process the result and showing digital measurement by software. It could be selected voltage adjust mode through software and adjust through the control circuit via hardware without passing computer. By set up the release circuit in Primary and Secondary of Auto transformer. Set up digital measurement system which is volt meter and amp meter to measurement both primary and secondary of auto transformer and prevent the emergency stop. Release circuit in case of emergency.

### 2.4 Components of a set of software voltage adjustment via software.

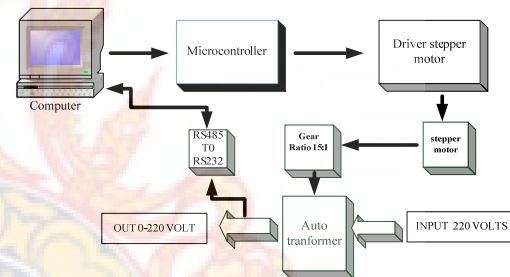

Figure 2.9 Showing Block Diagram, Structure of Voltage Adjustment Set Components of a set of hardware voltage adjustment

#### 2.4.1 Term of Hardware

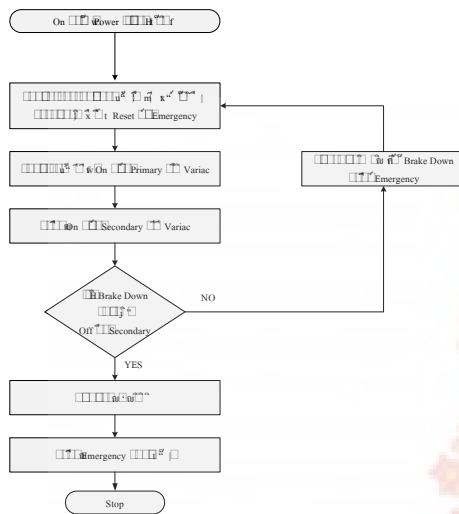

Figure 2.10 Showing Flow Chart Hardware Process

Graphic Design Program

2.4.2 Monitor will enter the detail of user and pass word into the main screen for using program.

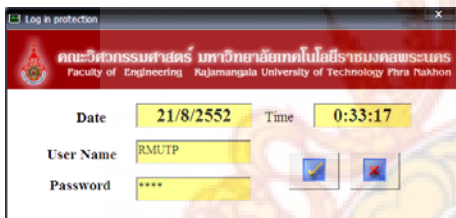

Figure 2.11 Showing screen to enter pass word

2.4.3 Main menu for selecting mode in several working of electric voltage adjustment 0-220 volt program

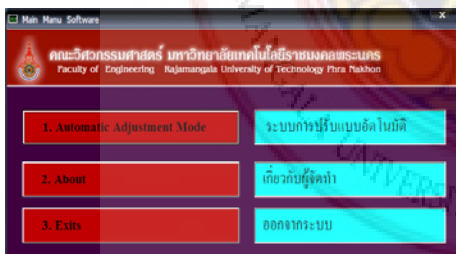

Figure 2.12 Showing Main Menu 3.4.3 Screen Mode for electric voltage adjustment auto system for enter through software and showing the measurement

system via software and event of several working.



Figure 2.13 Showing Screen Mode for Auto working and measurement System

Detail of electric voltage adjustment mode in auto system. Electric voltage adjustment through software system, Input is voltage that receive from meter to read parameter by electricity. It is voltage from output of auto transformer and volt meter output is amount of voltage system has specified at the voltage of 0-220 volt.

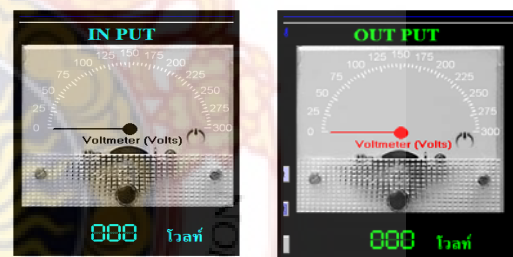

Figure 2.14 Showing Screen mode of measurement digital system via software

Mode showing event of working program and button contact that consist of Sending information part which is control microcontroller working Sending and receiving contact part with collecting parameter through electricity Controlling Pulse wind part in the speed of step motor





Figure 2.15 Showing Screen mode of working status and communication Mode of voltage adjustment to increase coarse and elaborate to protect voltage specify in the electric voltage

electric voltage level Controlling button for Manual/Stop adjustment Delete information button which is used for deleting electric voltage information that has specify Stop button which is used for stop working Turn off button which is used for back to main menu



Figure 2.18 Showing mode of electric voltage controlling.



Figure 2.16 Showing mode of voltage adjustment by increasing amount

#### 2.4.4 Screen mode of manipulator and advisor

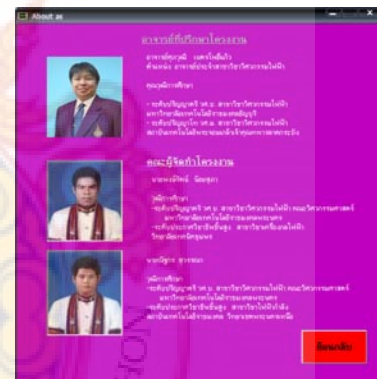

Figure 2.19 Showing mode of Manipulator and Advisor

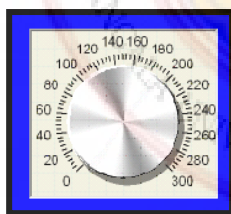

Figure 2.17 Showing mode of voltage adjustment by increasing amount via graphic

Controlling electric voltage, it can be adjust through computer software and working by controlling circuit system or Manual system which has design for using in those two modes. These two modes can adjust the speed of rolling motor for drive the level of suitable voltage in testing and using set of electric voltage.

Mode of control voltage consist of Button to increase and reduce the

### 3. Testing Result

Testing result of digital measurement and processed through meter software

**Table 3.1** Comparing Electric Voltage from program and multi meter

Area Measure	Digital meter PM	Digital meter Richmas	Software Instrument
1	-	-	-
2	-	-	-
3	3	3.297	3
4	4	4.036	4.089
5	5	5.345	5.244
6	6	6.145	6.188
7	7	7.469	7.655
8	8	8.375	8.375
9	9	9.521	9.412
10	10	10.39	10.52
11	11	11.35	11.39
12	12	12.42	12.36
13	13	13.29	13.27
14	14	14.35	14.38
15	15	15.38	15.30
16	16	16.24	16.32
17	17	17.01	17.01
18	18	18.33	18.30
19	19	19.23	19.23
20	20	20.38	20.35
21	21	21.04	21.04
22	22	22.16	22.16
23	23	23.31	23.31
24	24	24.24	24.24
25	25	25.28	25.28

**Table 3.2** Comparing Electric Voltage from Program and Multi Meter (Continuous)

Area Measure	Digital meter PM	Digital meter Richmas	Software Instrument
201	201	201.5	201.5
202	202	202.4	202.4
203	203	203.6	203.6

204	204	204.7	204.7
205	205	205.1	205.1
206	206	206.5	206.5
207	207	207.6	207.6
208	208	208.0	208.0
209	209	209.5	209.5
210	210	210.9	210.9
211	211	211.4	211.4
212	212	212.0	212.0
213	213	213.8	213.8
214	214	214.0	214.0
215	215	215.0	215.0
216	216	216.6	216.6
217	217	217.5	217.5
218	218	218.5	218.5
219	219	219.3	219.3
220	220	220.7	220.7



Figure 3.1 Showing result of voltage adjustment via software 0 volt



Figure 3.2 Showing result of voltage adjustment via software 10 volt

#### 4.1 Conclusion

Design and create the voltage machine 0-220 Volt through software by adjust the level of voltage to low of Auto Transformer which has adjust core by stepper motor and control working process by software and showing the digital measurement system via software. This project would be advantage.

To test all the devices that would use for study about high voltage engineering that is development electric voltage sector and voltage measurement system to be safety from high voltage that creating in lab.

#### 4.2 Summary Result from Research

According from studying, design, create and testing project. This project could be used according to objective and determine and pattern can be real using. Voltage INPUT 220 V; 1 PHASE; 50 HZ; 10k VA 65A and electric voltage adjustment OUTPUT from 0-220 Volt. Characteristic of electric voltage adjustment OUTPUT via software system including Manual system and showing measurement system in reading the electric power or parameter by electricity in digital form and measurement digital system processing via software. This project could send voltage electricity to INPUT of testing transformer size 10 kVA. There has been set up the system to control adjustment which would be suitable in testing characteristic. When testing devices of high voltage of transformer changing and Breakdown. There are emergency button or Emergency stop for break down voltage circuit out of device immediately.

#### 4.3 Recommendation

According to this project, manipulator has set up meter for electric power that could be read the amount of several parameters. Electricity has 28 parameters and it is most accuracy. The manipulator has written function program to pull out the parameter in the software. Idea of development should bring the amount of energy to be Data base and showing the testing result into report by using program Crystal Report. It would help to

know the testing result and bring the result to analysis. In having computer device, it's control voltage setting. There are speedy interrupt signal and high voltage magnate filed of testing device. Therefore, it should develop together with the wireless which the manipulator has written program to support working. Furthermore, some voltage is feedback so that it should be able to set up device to protect voltage feedback which would effect to the accuracy of measurement system to control electric voltage from 0-220 volt via software. There could be both supply and analysis that safety. The accuracy of measure system and many functions for using in work by focus on tester and testing device has mainly safety form electric voltage.

#### 5. References

- 1) Chantawut Peachpol, PichitSantikulanon, Promleart Lorvichit "Visual Basic Handbook New Edition, Edition 11"
- 2) Kitti Pakwatanakul, Chumlong Kruautsaha "Visual Basic 6 Programmer Edition"
- 3) VB Motion For Control Instruction Media "MECHATRONICS LAB "
- 4) Visual Basic For Application Control Instruction Media "MECHATRONICS LAB "
- 5) Visual Basic 6.0 Instruction Media MIS Soft Tech Com., Ltd.
- 6) Worapoj Kornkreawatthanakul, Chaiwatthakul "Learning and Microcontroller Operation MCS – 51 "
- 7) Apisit Aekwanondh, Perapat Sirisanon, Polawat Amornwiwat "Master Thesis, Computer Applications Position control" King Mongkut's University of Technology
- 9) Electric Machinery Fundamentals Third Edition By Stephen J. Chapman Mcgraw – hall international edition [ Electric Machinery Series ]